

# MARKERLIGHTS

3157.2105124

LED marker light | 12-24V | amber

EAN: 5414184018013

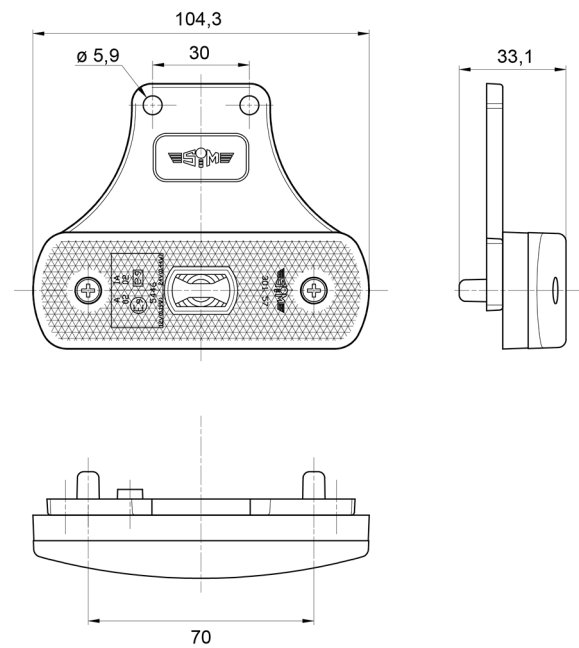

## Specifications

ADR approved	Yes	Mounting	Bracket
Certification	ECE R3+R91	Mounting side	Side
Color	Amber	Operating voltage	12V - 24V
Colour of lens	Amber	Supplied with	Mounting screws
Connection	Open cable ends	To be ordered by	1
Dimensions	104 x 63 x 33 mm	Waterproof	Yes
EMC	EMC R10	Weight (kg)	0,082 Kg
EMC R10	Yes		
Functions	Side position marker		
Light source	LED		