

ROTATING BEACONS

59524C

Rotating beacon | 3 bolt mount | 24V | white

EAN: 5414184010789

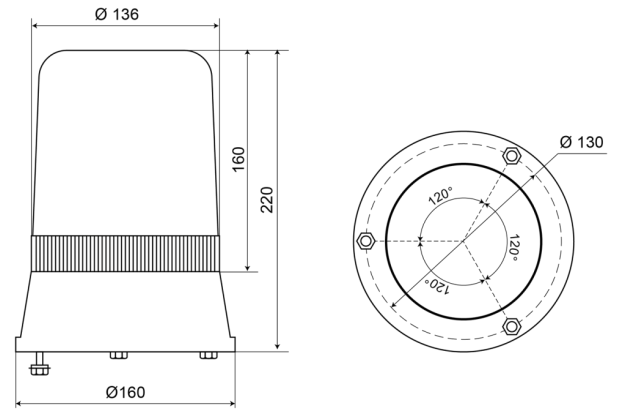

Specifications

Color	White	IP-degree	IP65
Connection	Open cable ends	Light source	Halogen
Diameter mm	160 mm	Mounting	3 bolt mounting
Diameter range	171 - 210 mm	Operating voltage	24V
ECE R65	No	Operation temperature	-30°C / +50°C
EMC	EMC	Rotations/minute	180 +/- 30
Height mm	220 mm	To be ordered by	1
Height range	211 - 240 mm	Weight (kg)	1,200 Kg